

MY CARDBOARD RECORD PLAYER

Upcycling

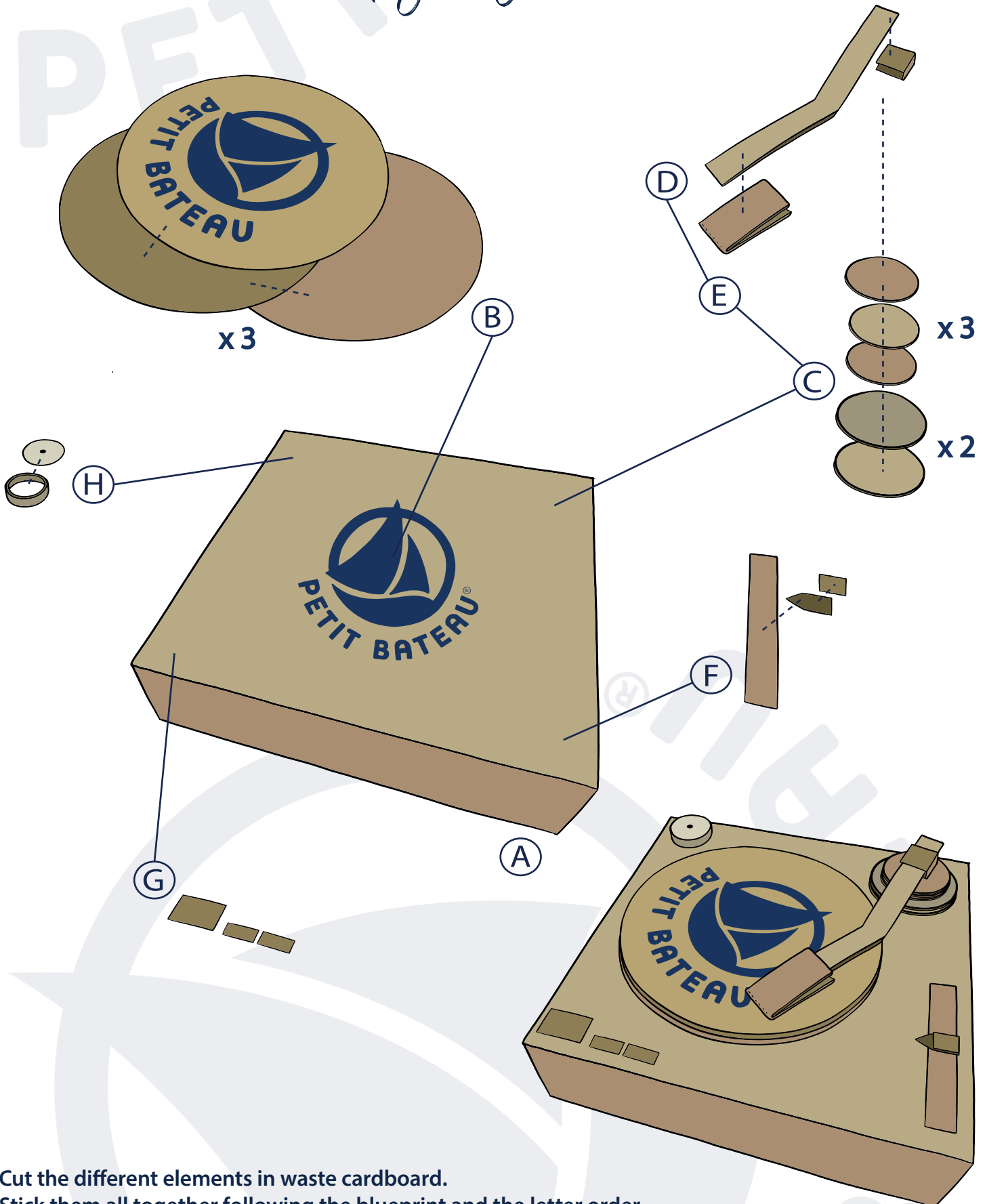

Cut the different elements in waste cardboard.
Stick them all together following the blueprint and the letter order.
To make the vinyls, reproduce B elements and draw furrows.

MY CARDBOARD RECORD PLAYER

Upcycling

All measurements are indicative, adjust in accordance of the cardboard thickness and the dimension of the one used as a base (A).

DIMENSIONS

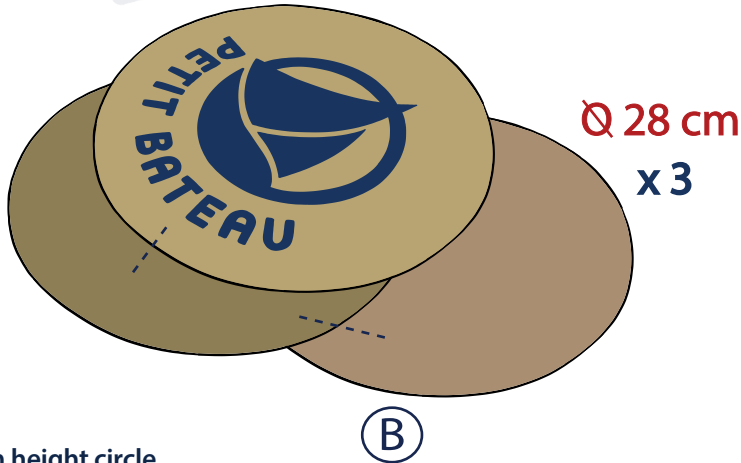

Cut a 1,5 cm height circle in a toilet roll.

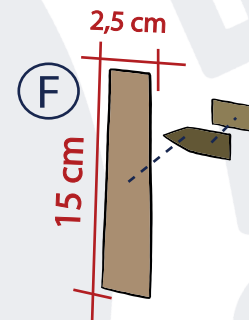
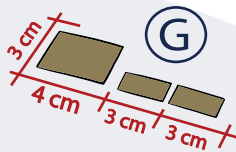
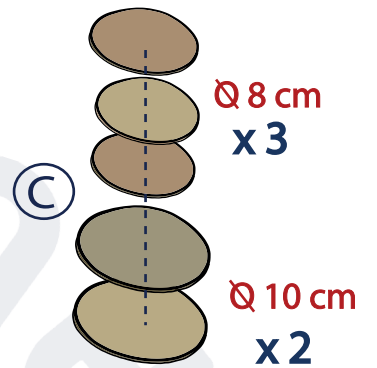
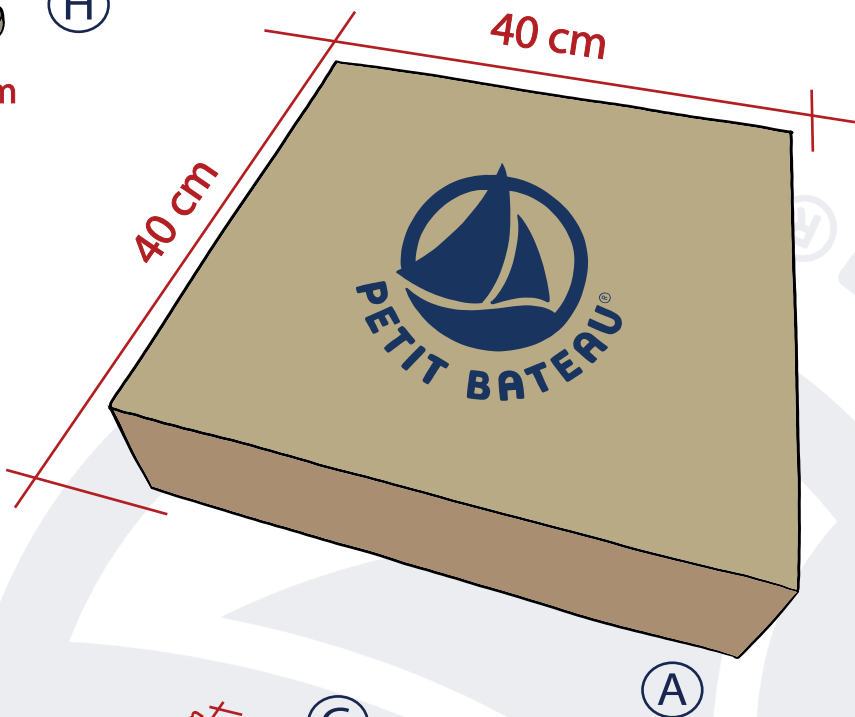
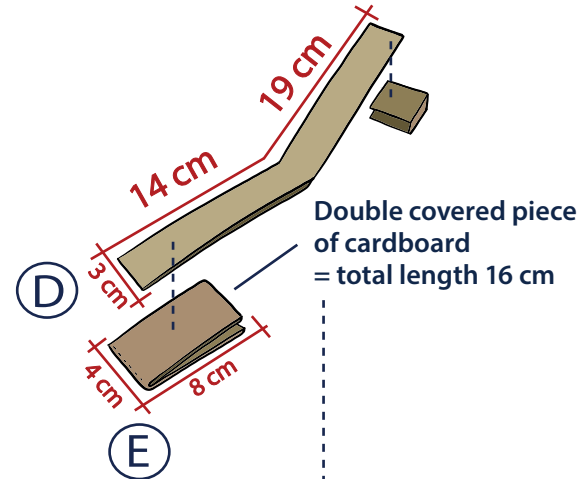
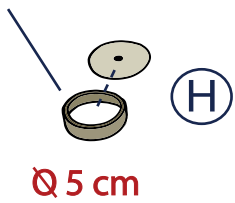

NB : To make the vinyls, reproduce B elements and draw furrows.